



Installing Light Trap for Fan

HIRED-HAND®

⚠ Warning!

Disconnect All Electrical Power Sources Before Installing Light Trap

Tools Required

Power Drill	Level	Tape Measure
3/8" Driver	5/16" Driver	1/4" Driver

Description

These instructions are for a Light Trap installed over a fan used in a poultry confinement building. See Figure 1. The Light trap is available in sizes shown in Table 1.

Light Trap Size	Part Number
72"(H)x72"(W) Blackout	6624-2100
72"(H)x60"(W) Blackout	6624-2101
60"(H)x60"(W) Blackout	6624-2102
48"(H)x48"(W) Blackout	6624-2103
36"(H)x36"(W) Blackout	6624-2099

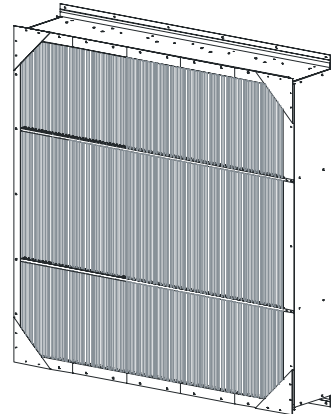

Figure 1 – Light Trap over Fan

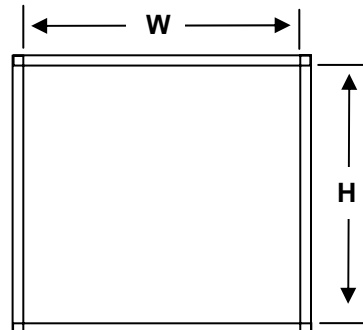

Figure 2 – Light Trap Framing Dimensions

Framing Dimensions

The framing dimensions for the Light Traps are shown in the following table. See Figure 2 for framing layout.

Trap Width	W	Trap Height	H
72"	72"	72"	72"
60"	60"	60"	60"
48"	48"	48"	48"
36"	36"	36"	36"

Assembly Instructions

STEP 1

Locate a flat surface on the ground and assemble the Top, Bottom and Sides using 3/8" x 1/2" tap screws (1004-0080). See Figure 3.

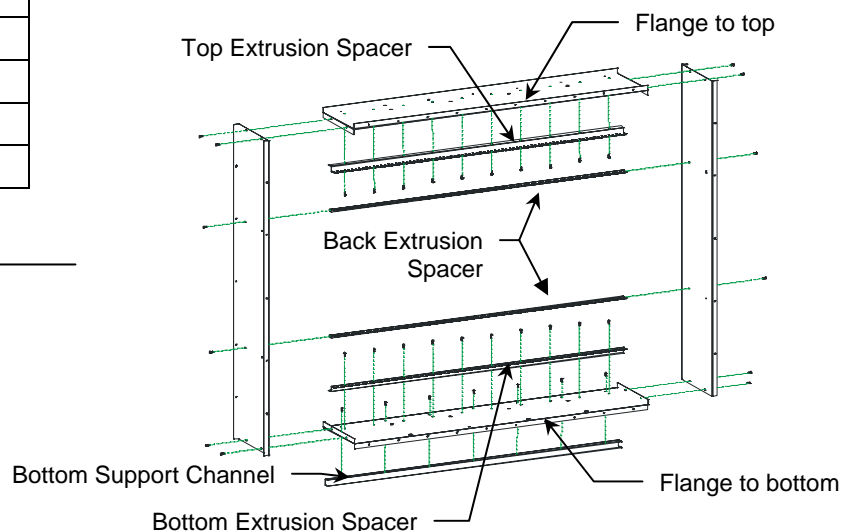

Figure 3 – Assemble Top, Bottom and Sides

STEP 2

Attach the Top/Bottom Rear External Spacer to the other Top and Bottom Panel using 1004-0080 tap screws. See Figure 3.

STEP 3

Attach the Bottom Support Channel to the Bottom Panel using 1004-0080 tap screws. See Figure 3.

STEP 4

Attach the Back Extrusion Spacer to the Sides using 1004-0080 tap screws. See Figure 3.

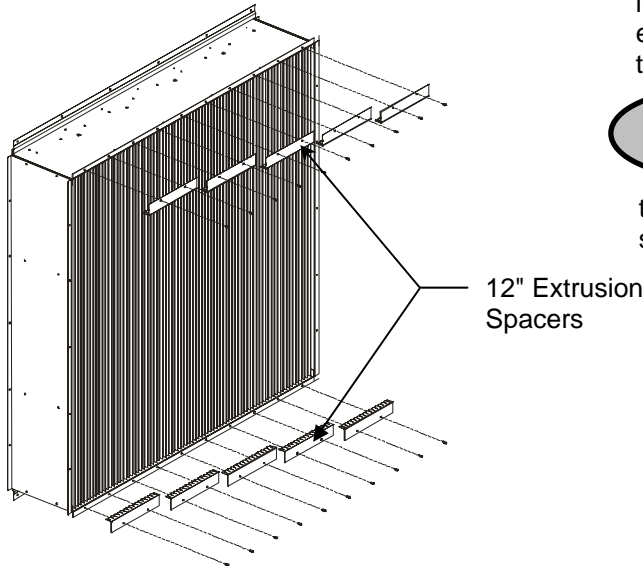

Figure 5 - Fan Extrusion Spacers

STEP 7

Attach the Left and Right Trim using five 1004-0080 screws. See Figure 6.

STEP 8

Attach the two Front Extrusion Spacers to the unit using four 1004-0080 tap screws per Spacer. See Figure 6.

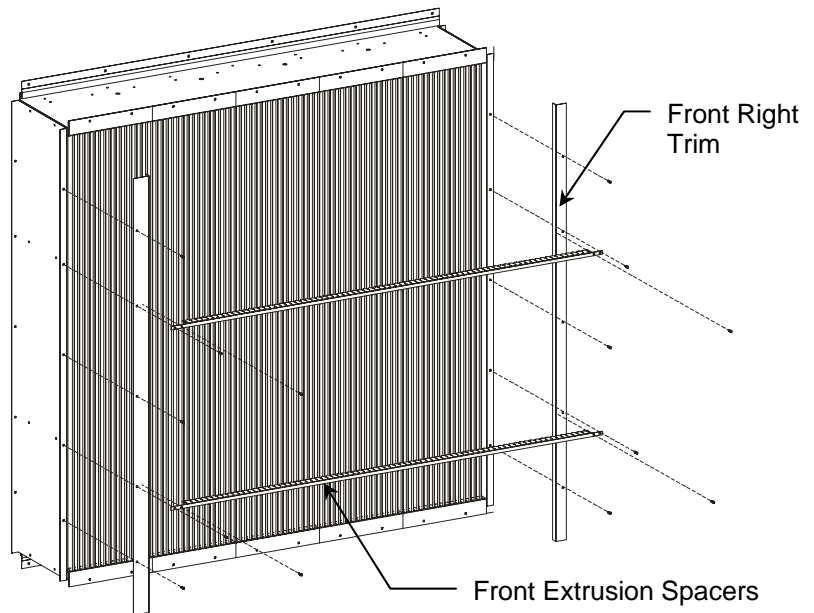

Figure 6 – Install Left and Right Trim

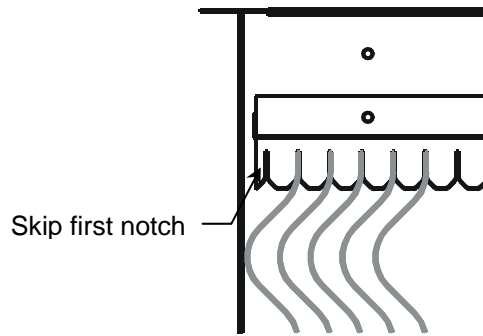

Figure 4 – Install Extrusions

STEP 5

With the front of the Light Trap facing upward, install the Extrusions. See Figure 4. The two ribs of the extrusion should face the left of the unit. Install Extrusions left to right skipping the first notch spacers.

STEP 6

Attach the 12" Extrusion Spacers along the Top and Bottom of the unit using two 1004-0080 screws per 12" Spacer. See Figure 5.

STEP 9

Attach the Corner Gusset to each corner of the unit using four 1004-2492 tek screws per Gusset. See Figure 6.

STEP 10

Attach Mounting Angles to the wall using 1004-0054 lag bolts. NOTE: The bottom of the lower angle and the top of the upper angle should be 5" longer than the ordered unit. See Table 2

STEP 11

Stand the unit upright and attach Foam Adhesive to both sides. See Figure 7.

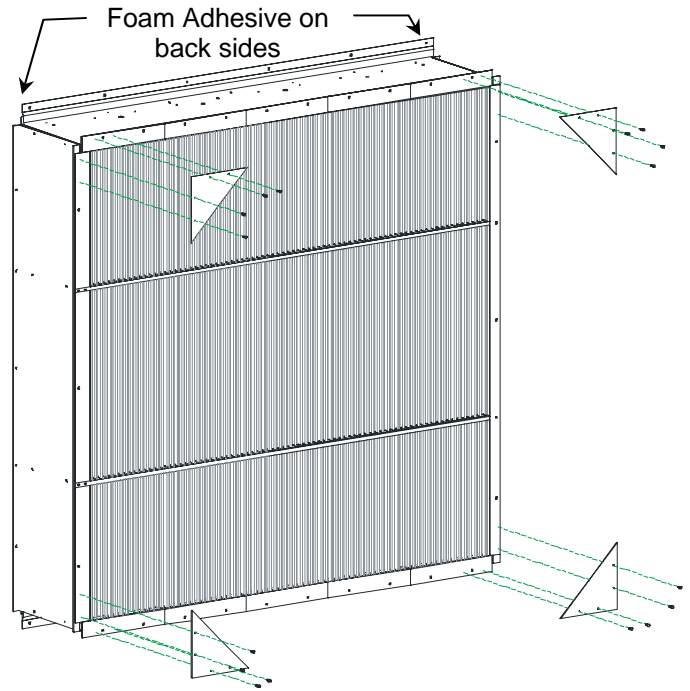

Figure 7 – Fan Corner Gussets

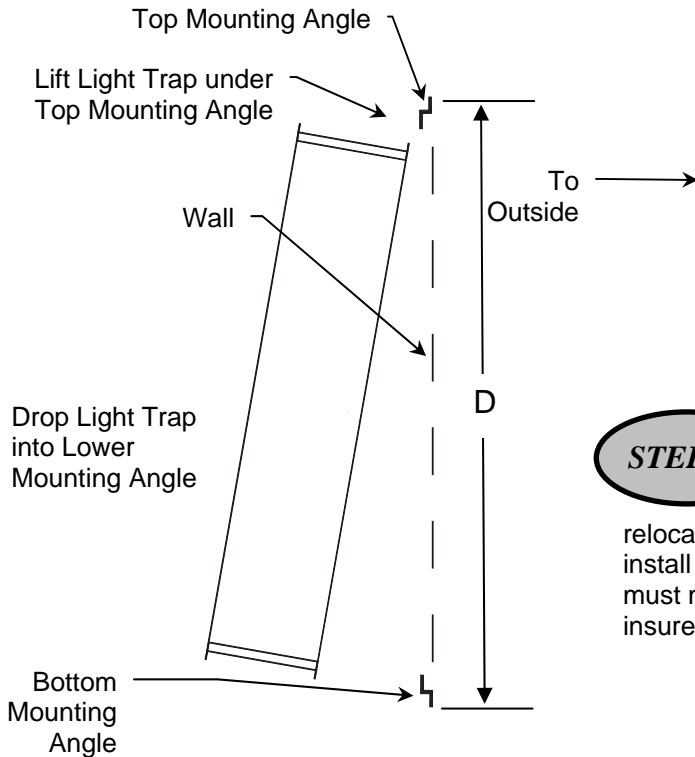

Figure 8 – Install Mounting Angles

Table 2 – Mounting Distance	
Height	D
72"	77"
60"	65"
48"	53"
36"	41"

STEP 12

Disconnect the power cord to the fan and relocate the power cord through the Light Trap. Do not install the fan over the power cord! The Foam Adhesive must make a firm contact with the mounting surface to insure a good light seal. See Figure 8.

Relocate the fan power cord through the Light Trap Extrusions

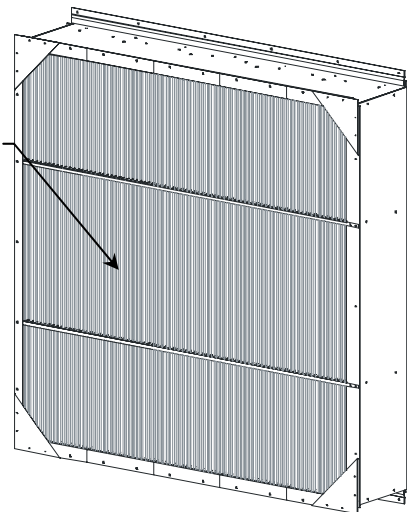

Figure 9 – Completed Light Trap





STEP 13

Lift unit into the Top Mounting Angle and drop into the lower angle, which will hold the unit in place during operation. Take up any slack left in the power cord. See Figure 8.

STEP 14

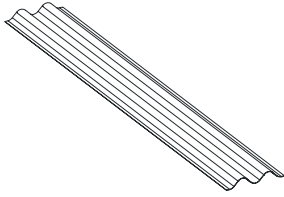
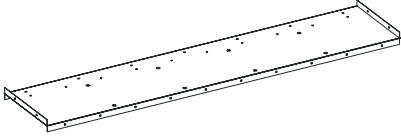
Installation Complete. See Figure 9.

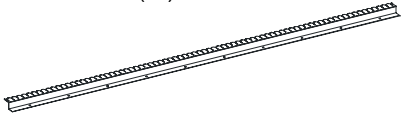
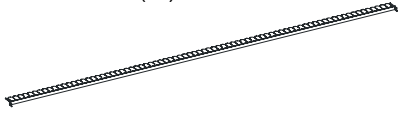
Parts List

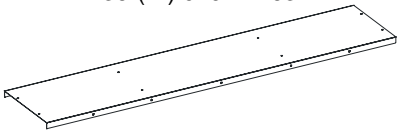
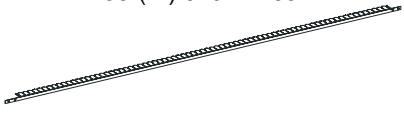
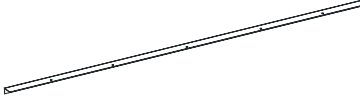
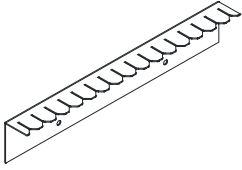
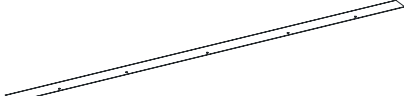
<p>Extrusion 71.5"(H) 0006-8000 59.5"(H) 0006-8001 47.5"(H) 0006-8002 35.5"(H) 0006-8004</p> 	<p>Top 72"(W) 0404-7055 60"(W) 0404-7057 48"(W) 0404-7058 36"(W) 0404-7764</p> 	<p>Bottom Support Channel 72"(W) 0404-7188 60"(W) 0404-7189 48"(W) 0404-7190 48"(W) 0404-7758</p> 
<p>Bottom 72"(W) 0404-7216 60"(W) 0404-7215 48"(W) 0404-7214 36"(W) 0404-7764</p> 	<p>Bottom Extrusion Spacer 72"(W) 0404-7068 60"(W) 0404-7071 48"(W) 0404-7073 36"(W) 0404-7762</p> 	<p>Back Extrusion Spacer 72"(W) 0404-7076 60"(W) 0404-7077 48"(W) 0404-7078 36"(W) 0404-7759</p> 
<p>Mounting Angle 72"(W) 0404-7080 60"(W) 0404-7082 48"(W) 0404-7084 36"(W) 0404-7757</p> 	<p>Sides 72"(H) 0404-7048 60"(H) 0404-7050 48"(H) 0404-7049 36"(H) 0404-7763</p> 	<p>Front Extrusion Spacer 72"(W) 0404-7067 60"(W) 0404-7070 48"(W) 0404-7072 36"(W) 0404-7765</p> 
<p>Right Trim 72"(H) 0404-7062 60"(H) 0404-7064 48"(H) 0404-7066 36"(W) 0404-7761</p> 	<p>12" Extrusion Spacer 0404-7094</p> 	<p>Left Trim 72"(H) 0404-7061 60"(H) 0404-7063 48"(H) 0404-7065 36"(W) 0404-7760</p> 
	<p>Corner Gusset 0404-7043</p> 